

SHARP

AR-5631/5625

Digital Multifunctional System



A Secure Copy and Print Performance Enhancer



..... **be sharp**

COPY

PRINT

FAX
OPTION

A Safeguarded Copier/Printer with Versatile Fax Option

The AR-5631/5625 handles copying and printing—the staples of everyday document demands—with seemingly effortless ease, time-saving speed, professional-looking image quality, and productivity-boosting functions. Adding the optional fax expansion kit covers all your document needs, while opting for the Data Security Kit keeps the whole system reliably protected. So tap into the multifunctional ease and efficiency of the AR-5631/5625. Let it be your ticket to better workflow, better performance.



PRODUCTIVE COPYING

Speedy Copying and Quick First Copy Time

The AR-5631/5625 has a quick first copy time of **4.5/4.8 seconds** to save valuable time when performing multiple short-run jobs. And with a continuous copy rate of up to **31/25 cpm***, you can do more copy jobs in less time.

* A4 (8 1/2" x 11") size, portrait



Electronic Sorting and Offset Stacking

The AR-5631/5625's Scan Once/Print Many (SOPM) function does one scan of multiple-page documents and stores them in memory for making up to **999 copies** of each page. The Electronic Sorting function then **automatically collates** multiple sets of copies in page order without the aid of a sorter. The AR-5631/5625 also stacks each set slightly shifted apart from the previous (**offset stacking**) for easy retrieval.

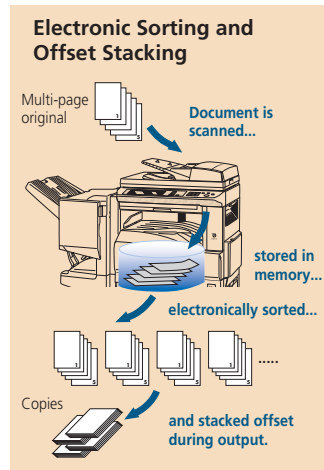

Automated Job Finishing

The AR-5631/5625 makes it easy to create professional-looking booklets. Working together with the highly productive built-in stackless duplex module, the optional **Saddle Stitch Finisher** folds and staples sets of documents to make completed booklets. A **Punch Module** allows you to punch holes in documents for easy filing. And, a **Finisher** is also available for jobs that require only simple sorting and stapling.

Various Types of Job Finishing with the Saddle Stitch Finisher

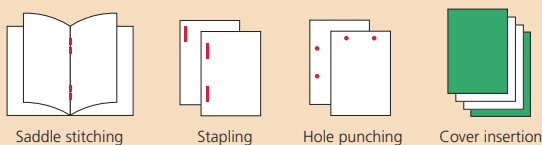

Built-in Duplex Module and Optional RSPF

The AR-5631/5625 can automatically produce **duplex copies** from one- or two-sided originals. This reduces paper costs and helps save filing space. Duplex copying is even more productive when used together with the **optional RSPF** (reversing single pass feeder), which efficiently feeds in up to **100 pages** of either one- or two-sided originals.

Job Build for Large-Volume Scanning

With optional extra memory installed, the AR-5631/5625 easily handles copy jobs exceeding the RSPF's 100-sheet capacity*¹. Large-volume documents of up to 2,970 pages*² are automatically stored in memory. Users can then print the entire document in a single run.

*¹: A4 (8 1/2" x 11") size

*²: Measured using Sharp's standard chart (A4 with 6% coverage). The actual storage limit depends on the amount of memory installed.

Versatile Editing Functions

The AR-5631/5625 is standard equipped with various image editing functions that make copying more convenient.

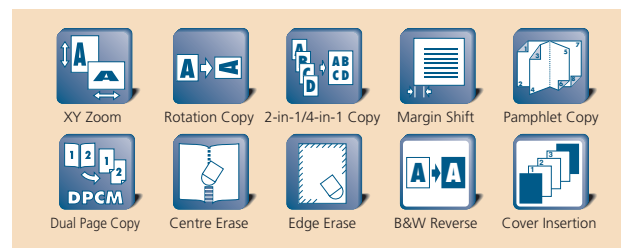

Other Key Features

- Standard 1,100-sheet paper capacity, expandable to max. 2,100 sheets
- Auto tray switching
- Card Shot enables one-touch copying of both sides of a card (credit cards, ID cards, etc.) onto a single page
- Digital Automatic Exposure Control and Text/Photo mode provide optimum copy quality

PERFORMANCE PRINTING

High-Quality Printing with Sharp Technology

The AR-5631/5625 is a high-performance printer incorporating Sharp Printer Language with Compression (SPLC) technology. SPLC effectively reduces the data size of print jobs, speeding up the data transfer time and printing process while improving overall throughput. Also, the RIP Once/Print Many function saves print data in the AR-5631/5625's internal memory and transfers it to output at a quick rate of **31/25 ppm**. Both **IEEE 1284** parallel and **USB 2.0** ports are provided as standard. The AR-5631/5625's 600-dpi printing resolution can be enhanced to **1,200 dpi** (with smoothing) for ultra-detailed reproduction.

Other Key Features

- Duplex printing • N-up • Fit-to-page • Watermarks

Job Offset and Job Separator

To make it easier to locate and retrieve your documents from the tray, the AR-5631/5625's Job Offset function stacks each print job slightly shifted apart from one another. In addition, a convenient Job Separator* outputs copied documents onto a separate tray, preventing them from getting mixed in with printouts and faxes.

* Requires optional AR-TR3

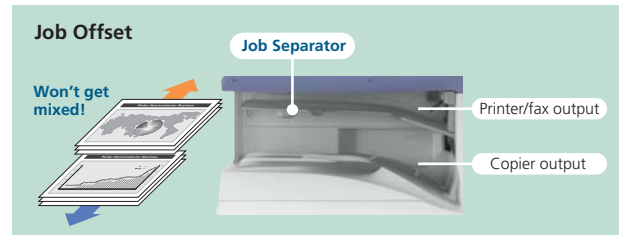

VERSATILE FAXING

High-Speed Operation

The optional AR-FX7 Fax Expansion Kit turns the AR-5631/5625 into a 33.6 Kbps **Super G3 fax**. Using JBIG compression technology, the AR-5631/5625 can send an A4 (8 1/2" x 11") size page in under 3 seconds*. Use the optional 100-sheet RSPF to further boost faxing efficiency. And because **Quick On-Line Transmission** can start dialling and transmitting as soon as the first page is scanned into memory, you can send documents in much less time.



* Based on Sharp's standard chart with approximately 700 characters (A4 or 8 1/2" x 11" portrait) at standard resolution

Duplex Transmission and Reception

With the optional RSPF, the AR-5631/5625 scans both pages of two-sided documents and sorts them in memory. The pages are then transmitted in the proper order. Thanks to the standard duplex module, the AR-5631/5625 can also print incoming faxes onto both sides of paper, thus saving you paper costs.

500-Number Auto Dialling

Register up to 500 numbers into the customisable directory of one-touch auto-dial keys, listed in alphabetical order for easy searches of specific numbers.

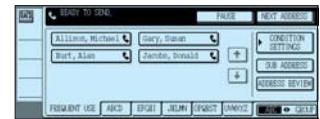

PC-Fax

A PC-Fax function allows you to directly send a document created on your PC to a fax machine without printing to paper. This function saves time, increases faxing productivity, and retains original document quality.

Other Key Features

- F-Code communication • Memory transmission and reception • Timer transmission • Broadcast transmission • Polling • Anti-junk fax

USER-FRIENDLY AND SECURE

8.1-Inch LCD Panel

The AR-5631/5625's logically designed control panel features a wide, clear touch-screen LCD with easy-to-follow guidance. For example, when adjusting the edge/centre erase function, the LCD displays step-by-step instructions to guide you through the necessary procedures.



Auditing Mode

An auditing mode requires users to enter a five-digit PIN code to gain access to the control panel. This feature also restricts users from printing to the AR-5631/5625.

Data Security Kit

Digital copier/printers or multifunction products can retain hundreds of pages of confidential information from previous jobs on their internal memory. To safeguard this information from unauthorised access, the optional **Data Security Kit** automatically **erases** the data after each job is complete.

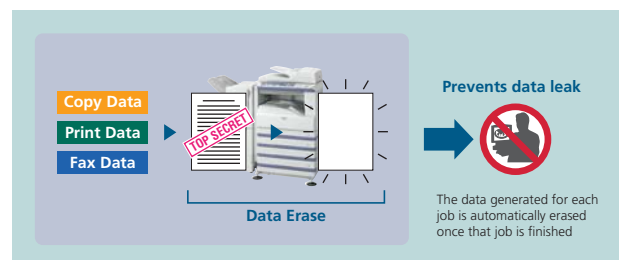

SPECIFICATIONS

| General | |
|---------------------------------------|---|
| Type | Desktop |
| Engine speed*1 | Max. 31/25 cpm/ppm |
| Paper size | Max. A3 (11" x 17"), min. A5 (5 1/2" x 8 1/2") |
| Paper capacity (80 g/m ²) | Standard: 1,100 sheets (two 500-sheet trays and 100-sheet multi-bypass tray) Maximum: 2,100 sheets |
| Warm-up time*2 | 25/23 sec. |
| Memory | Standard: 32MB Maximum: 1,056MB |
| Power requirements | Rated local AC voltage \pm 10%, 50/60 Hz |
| Power consumption (max.) | 1.45 kW (220 to 240V), 1.45 kW (100 to 127V) |
| Dimensions (W x D x H) | 623 x 615 x 665 mm (24 17/32" x 24 7/32" x 26 11/64") |
| Weight | Approx. 49.2 kg (108.5 lbs.) |
| Features | Job build, pre-heat/auto power shut-off modes, toner save mode, user control (100 accounts) |

| Copier | |
|---------------------|---|
| Original paper size | Max. A3 (11" x 17") |
| First copy time*3 | 4.5/4.8 sec. (document glass), 9.3/9.3 sec. (RSPF) |
| Continuous copy | Max. 999 copies |
| Resolution | Scan: 400 x 600 dpi Print: 600 x 600 dpi |
| Gradation | Scan: 256 levels Print: 2 levels |
| Zoom range | 25 to 400% (50 to 200% using RSPF) in 1% increments |
| Preset copy ratios | Metric: 10 ratios (5R/5E), inch: 8 ratios (4R/4E) |
| Features*4 | Auto paper selection (mixed size feeding), auto magnification selection, paper type selection, auto tray switching, rotation copy, electronic sorting, margin shift, dual page copy, multi-shot (4-in-1, 2-in-1), cover insertion, pamphlet copy, 2-sided copy orientation change, XY zoom, B/W reverse, duplex copy, job programme, card shot, edge/centre erase |

| Printer | |
|---------------------|--|
| Resolution | 600 x 600 dpi |
| Enhanced resolution | 600 x 1,200 dpi equivalent with smoothing |
| Interface | IEEE 1284, USB 2.0 |
| Supported OS*5 | Windows NT® 4.0 SP5 or later, Windows® 98/Me/2000/XP, Windows Vista™ |
| Printer language | SPLC (Sharp Printer Language with Compression) |
| Features | RIP Once/Print Many, duplex print, N-up (2/4), paper/output tray selection, fit to page, watermarks, offset output |

SYSTEM CONFIGURATION

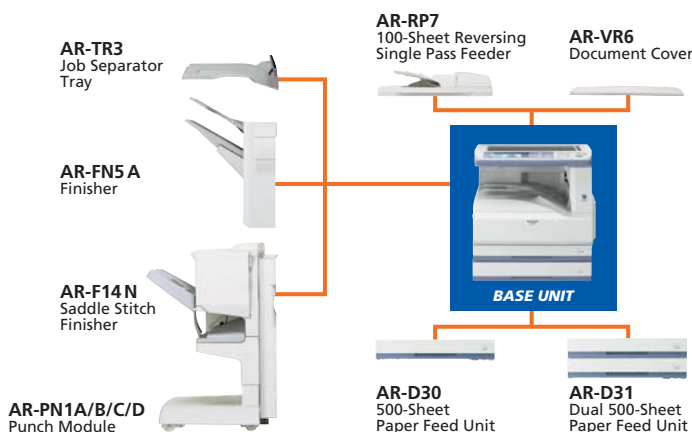

AR-FX7
Fax Expansion Kit
AR-MM9
8MB Fax Memory
AR-SM5/SM6
256MB/512MB Expansion Memory Board

Available at a later date
AR-FR24U/FR25U
Data Security Kit
AR-FR24/FR25
Data Security Kit
(Common Criteria validated)

| Facsimile (optional AR-FX7 required) | |
|--------------------------------------|---|
| Compression method | MH/MR/MMR/JBIG |
| Communication protocol | Super G3/G3 |
| Transmission time | Less than 3 seconds*6 |
| Modem speed | 33,600 bps to 2,400 bps with automatic fallback |
| Transmission resolution | From Standard (203.2 x 97.8 dpi) to Super Fine (406.4 x 391 dpi) |
| Recording width | A3 to A5 (11" x 17" to 5 1/2" x 8 1/2") |
| Memory | Standard 2MB, expandable to 10MB |
| Grey scale levels | Equivalent to 256 levels |
| Features*4 | Duplex transmission/reception, quick on-line transmission, error correction mode, 500 one-touch dials, F-Code compatibility (confidential, relay broadcast), group dials (up to 50 groups and 200 destinations), 8 job programmes, broadcasting number registration, polling, memory transmission/reception, auto reduction (transmission/reception), rotation transmission/reception, long original transmission (max. 1,000 mm)*7, print actual size, PC-Fax transmission, timer transmission, activity report, anti-junk fax, dual page scan |

*1: Copy mode: When copying same document continuously on portrait A4 (8 1/2" x 11") plain paper in non-offset mode. Print mode: When printing same document continuously on portrait A4 (8 1/2" x 11") plain paper in non-offset mode, excluding processing time. *2: Door left open for 60 seconds, standard condition, polygon motor stopped. *3: Portrait feeding of A4 (8 1/2" x 11") sheets from main unit's 1st paper tray, polygon motor running. *4: Some features require option(s). *5: Windows Vista available at a later date. *6: Based on Sharp's standard chart with approx. 700 characters (A4 or 8 1/2" x 11" portrait) at standard resolution in Super G3 mode, 33,600 bps, JBIG compression. *7: Not available in Super Fine mode.

- Design and specifications are subject to change without prior notice.
- Windows and Windows Vista are either registered trademarks or trademarks of Microsoft Corporation in the United States and/or other countries. All other brand names and product names may be trademarks or registered trademarks of their respective owners.
- The Energy Star logo is a certification mark and may only be used to certify products that have been determined to meet the Energy Star programme requirements. Energy Star is a US registered mark. The Energy Star guidelines apply to products only in the US, Europe, Australia, New Zealand, and Japan.

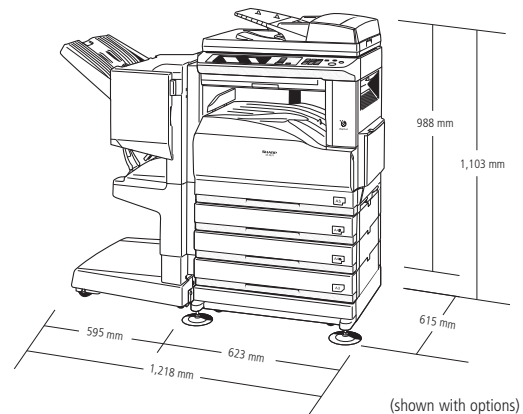

Note: AR-F14N requires AR-D30 or AR-D31 and locally available cabinet. Some options may not be available in some areas.

SHARP
SHARP CORPORATION OSAKA, JAPAN

SHARP BUSINESS SYSTEMS (INDIA) LIMITED

214-221, ANSAL TOWER, 38 NEHRU PLACE, NEW DELHI 110 019,
TEL.: 26431313, 26438866; FAX: 26438747/48; URL <http://www.sbsil.com>

Toll Free: 1800-4254-321 - ALL INDIA

North: New Delhi: 26431313, 26438866 • Chandigarh: 5079536, 2647745 • Jaipur: 5106950 • Lucknow: 2324796
East: Kolkata: 22816743 / 9831249945 • Guwahati: 2662216
West: Mumbai: 66793931 / 32 • Pune: 25531010, 25520608 • Raipur: 2582367 • Ahmedabad: 30022961 / 26580734
South: Bangalore: 22353535 - 38 • Chennai: 28171562, 28172538 • Hyderabad: 55208081 / 82 • Kochi: 2314154